

Horizon Empfangstheken



COUNTERS / THEKEN

UPPER PART / AUFSATZ

UPPER PART FRONT / FRONT	Version 1 melamine chipboard (MFC) 25mm / Platte melaminharzbeschichtet 25 mm	Version 2 varnished MDF 25mm, milled in horizontal lines / MDF lackiert 25 mm, mit horizontaler Streifenführung	Version 3 glass 10mm thick, sand-blested in horizontal lines / Sandglas mit horizontaler Streifenführung 10mm
UPPER PART CARCASS / KORPUS UND ABDECKPLATTE	Version 1 melamine chipboard (MFC) 25mm / Platte melaminharzbeschichtet 25 mm	Version 2 varnished MDF 25mm / MDF lackiert 25 mm	

COUNTER / THEKE

FRONT OF THE COUNTER / FRONT	Version 1 HPL and melamine chipboard (MFC) / HPL und Melamin	Version 2 varnished MDF 25mm, milled in horizontal lines / MDF lackiert 25 mm, mit horizontaler Streifenführung	Version 3 natural veneer / Furnier
DESKTOP / TISCHPLATTE	Version 1 desktop in one piece, melamine chipboard (MFC) / Ganze Platte - melaminbeschichtet	Version 2 desktop divided into two parts: -Front part made from MDF or melamine chipboard (MFC); -rear part (working desktop) made from melamine chipboard (MFC) / Vorderer Teil aus Melamin oder MDF lackiert, hinterer Teil aus Melamin.	
COUNTER CARCASS / KORPUS	melamine chipboard (MFC) 25mm, colour quartz 2424 / Platte melaminharzbeschichtet, Stärke 25mm, Farbe Quarz 2424		
BOTTOM PLINTH / SOCKEL	chipboard covered with HPL - colour aluminium / HPL- Aluminium		
RAILING	two kinds: upper and lower, upper fixed to the upper edge of the front panel or lower railing fixed to the bottom plinth. Made of stainless steel, diameter of 25mm. The railing should be ordered along with the counter, as it is assembled in the production process. / Zwei Optionen: obere Railing: befestigt an den oberen Ecken der Thekenfront. Untere Railing: montiert an den Thekensockel; rostfrei gebürstetes Stahl, Durchmesser 25 mm. Die Railings werden im Produktionsprozess montiert. Bei Bestellung von Modulen mit Railing bitte die Anordnung dieser an die Theke angeben		
PACKING / VERPACKUNG	Assembled, only desktop is disassembled. Packed in foil, corners secured with foam, on a palette / Anlieferung auf Palette komplett aufgebaut (außer Tischplatte) Verpackung: Folie, Ecken mit Schaum gesichert		

1. UPPER PART FRONT / FRONT

- melamine / Melaminplatte
- Varnished MDF mat / MDF lackiert Struktur
- sand-blasted glass / Sandglas

2. UPPER PART CARCASS / KORPUS

- melamine / Melaminplatte
- Varnished MDF mat / MDF lackiert Struktur

3. FRONT OF THE COUNTER / FRONT

- HPL, melamine / HPL, Melaminplatte
- Varnished MDF mat / MDF lackiert Struktur
- natural veneer / Furnier

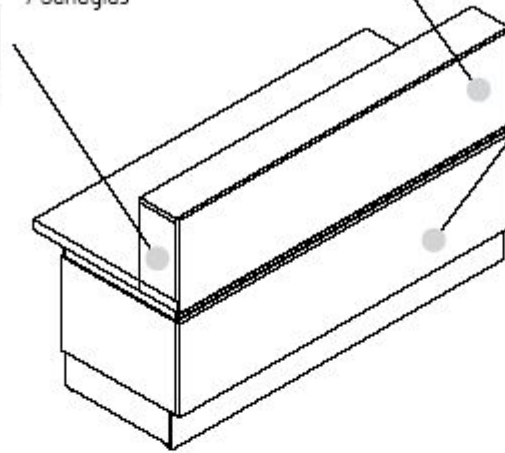

4. DESKTOP / TISCHPLATTE

- melamine / Melaminplatte

5. FRONT PART OF DESKTOP / VORDERE PLATTEN

- melamine / Melaminplatte
- Varnished MDF mat / MDF lackiert Struktur

6. BOTTOM RING / SOCKEL

- HPL

7. UPPER RAILING / OBERE RAILING

- stainless steel / Rostfreies Stahl

8. LOWER RAILING / UNTERE RAILING

- stainless steel / Rostfreies Stahl

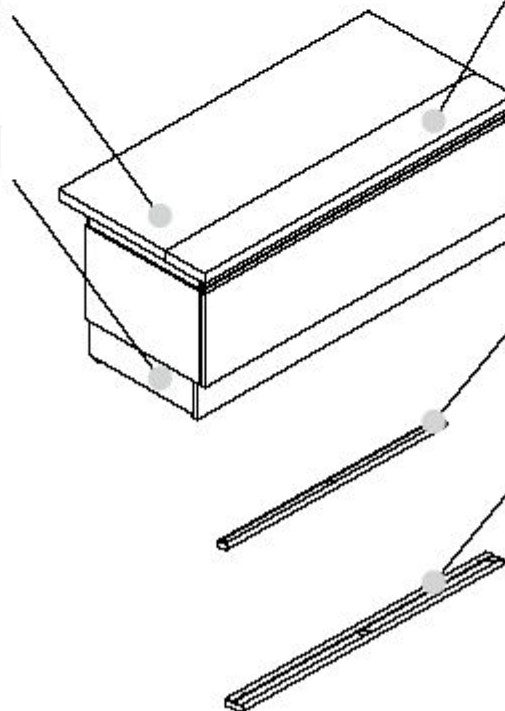

1. UPPER PART FRONT / FRONT AUFSAITZ

- melamine / Melaminplatte
- 0400 natural oak / Eiche natur
- 1500 birch / birke
- 0705 light cherry / helle Kirsche
- 2302 natural walnut / naturnuss
- 0900 tuari / tuari
- 2300 dark walnut / dunkle nuss
- 2700 white / Weiß
- 2850 sand / sand
- 2424 quartz / quartz
- 0300 graphite / grafit
- 0603 light beech / Helle buche
- 0702 cherry / Kirsche
- 1300 dark calvedos / dunkel calvedos
- 1201 grey / lichtgrau
- 2800 cappuccino / cappuccino
- Varnished MDF mat / MDF lackiert Struktur
- R mat white / matt Weiß
- S new quartz / neues quartz
- TS mat sand / matt sand
- U deep grey / Tiefes grau
- W dark graphite / intensives grafit
- B mat black / matt schwarz
- E light grey / lichtgrau
- sand-blested glass / Sandglas
- graphite / Grafit
- clear / Klarglas

4. DESKTOP / TISCHPLATTE

- melamine / Melaminplatte
- 0400 natural oak / Eiche natur
- 1500 birch / birke
- 0705 light cherry / helle Kirsche
- 2302 natural walnut / naturnuss
- 0900 tuari / tuari
- 2300 dark walnut / dunkle nuss
- 2700 white / Weiß
- 2850 sand / sand
- 2424 quartz / quartz
- 0300 graphite / grafit
- 0603 light beech / Helle buche
- 0702 cherry / Kirsche
- 1300 dark calvedos / dunkel calvedos
- 1201 grey / lichtgrau
- 2800 cappuccino / cappuccino

2. UPPER PART CARCASS / KORPUS AUFBAITZ

- melamine / Melaminplatte
- 0400 natural oak / Eiche natur
- 1500 birch / birke
- 0705 light cherry / helle Kirsche
- 2302 natural walnut / naturnuss
- 0900 tuari / tuari
- 2300 dark walnut / dunkle nuss
- 2700 white / Weiß
- 2850 sand / sand
- 2424 quartz / quartz
- 0300 graphite / grafit
- 0603 light beech / Helle buche
- 0702 cherry / Kirsche
- 1300 dark calvedos / dunkel calvedos
- 1201 grey / lichtgrau
- 2800 cappuccino / cappuccino
- Varnished MDF mat / MDF lackiert Struktur
- R mat white / matt Weiß
- S new quartz / neues quartz
- TS mat sand / matt sand
- U deep grey / Tiefes grau
- W dark graphite / intensives grafit
- B mat black / matt schwarz
- E light grey / lichtgrau

5. BOTTOM RING / SOCKEL

- HPL
- aluminium / Aluminium

7. UPPER RAILING / OBERE RAILING

- stainless steel / Rostfreies Stahl

8. LOWER RAILING / UNTERE RAILING

- stainless steel / Rostfreies Stahl



3. FRONT OF THE COUNTER / FRONT THEKE

- HPL, melamine / HPL, Melaminplatte
- 0400 natural oak / Eiche natur
- 1500 birch / birke
- 0705 light cherry / helle Kirsche
- 2302 natural walnut / naturnuss
- 0900 tuari / tuari
- 2300 dark walnut / dunkle nuss
- 2700 white / Weiß
- 2850 sand / sand
- 2424 quartz / quartz
- 0300 graphite / grafit
- 0603 light beech / Helle buche
- 0702 cherry / Kirsche
- 1300 dark calvedos / dunkel calvedos
- 1201 grey / lichtgrau
- 2800 cappuccino / cappuccino
- Varnished MDF mat / MDF lackiert Struktur
- R mat white / matt Weiß
- S new quartz / neues quartz
- TS mat sand / matt sand
- U deep grey / Tiefes grau
- W dark graphite / intensives grafit
- B mat black / matt schwarz
- E light grey / lichtgrau

- natural veneer / Furnier
- 4600 sentos palisander
/ sentos palisander
- 4100 natural walnut / naturnuss
- 4147 walnut stained in wenge
/ euf wenge gefärbte nuss
- 4900 natural oak / Eiche natur
- 4947 oak stained in wenge
/ schwarzEiche
- 4949 oak lacquered in white
/ weiß lackierte Eiche
- 4948 white washed oak
/ aufgehellte Eiche

VIEW AND PROJECTION OF THE OBJECT / ANSICHT DES OBJEKTS	DIMENSIONS (in cm) / ABMESSUNGEN (in cm)			CATALOGUE NUMBER / PRODUKTSYMBOL	NET PRICE in EUR (without VAT) / PREIS in € ohne Mwst					
	WIDTH / BREITE	DEPTH / TIEFE	HEIGHT / HÖHE		UPPER PART: MELAMINE / AUFSATZKORPUS IN MELAMIN			UPPER PART: MELAMINE AND VARNISHED MDF / AUFSATZKORPUS IN MELAMIN UND MDF LACKIERT		
					FRONT: HPL AND MELAMINE / FRONT HPL- MELAMIN	FRONT: VARNISHED MDF / FRONT: MDF LACKIERT	FRONT: NATURAL VENEER / FRONT: FURNIER	FRONT HPL AND MELAMINE / FRONT HPL- MELAMIN	FRONT: VARNISHED MDF / FRONT: MDF LACKIERT	FRONT: NATURAL VENEER / FRONT: FURNIER

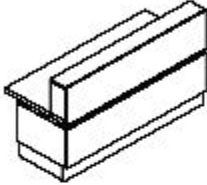
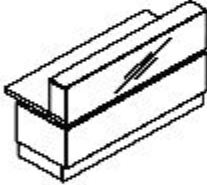
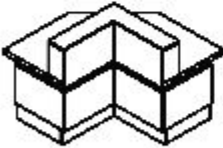
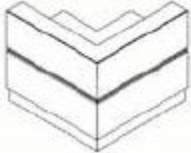
**COUNTERS
/ THEKEN**

	185	81	114	H1	1 464	1 548	1 766	1 619	1 777	2 005
	155			H2	1 201	1 331	1 529	1 386	1 524	1 730
	125			H3	1 072	1 186	1 366	1 223	1 342	1 529
	95			H4	921	1 016	1 178	1 037	1 136	1 304
	185	81	114	H5	2 357	2 526	2 766	2 472	2 646	2 890
	155			H6	2 077	2 224	2 440	2 171	2 321	2 540
	125			H7	1 868	1 994	2 189	1 949	2 079	2 277
	95			H8	1 635	1 741	1 913	1 706	1 814	1 989
	139/ 139	81	114	H17	1 491	1 560	1 717	1 677	1 753	1 918
	130/ 130	81	114	H20	1 642	1 740	1 980	1 957	2 067	2 318
				H40	2 953	3 019	3 267	3 062	3 220	3 402

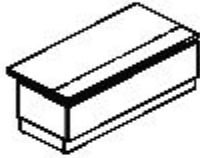
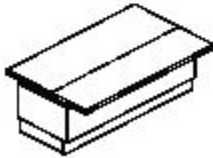

VIEW AND PROJECTION OF THE OBJECT / ANSICHT DES OBJEKTS	DIMENSIONS (In cm) / ABMESSUNGEN (In cm)			CATALOGUE NUMBER / PRODUKTSYMBOL	NET PRICE In EUR (without VAT) / PREIS In € ohne Mwst					
	WIDTH / BREITE	DEPTH / TIEFE	HEIGHT / HÖHE		DESKTOP: MELAMINE / TISCHPLATTE IN MELAMIN			DESKTOP: MELAMINE AND VARNISHED MDF / TISCHPLATTE IN MELAMIN UND MDF LACKIERT		
					FRONT: HPL AND MELAMINE / FRONT: HPL- MELAMIN	FRONT: VARNISHED MDF / FRONT: MDF LACKIERT	FRONT: NATURAL VENEER / FRONT: FURNIER	FRONT: HPL AND MELAMINE / FRONT: HPL- MELAMIN	FRONT: VARNISHED MDF / FRONT: MDF LACKIERT	FRONT: NATURAL VENEER / FRONT: FURNIER

**COUNTERS
/ THEKEN**

	185	81	74	H9	1 293	1 439	1 654	1 340	1 487	1 705
	155			H10	1 107	1 234	1 428	1 142	1 270	1 467
	125			H11	992	1 101	1 279	1 026	1 136	1 316
	95			H12	851	944	1 104	886	980	1 141
	185	106	74	H13	1 340	1 487	1 705	1 433	1 584	1 805
	155			H14	1 142	1 270	1 467	1 212	1 354	1 554
	125			H15	1 026	1 136	1 316	1 084	1 197	1 379
	95			H16	874	968	1 129	933	1 028	1 191

VIEW AND PROJECTION OF THE OBJECT / ANSICHT DES OBJEKTS	DIMENSIONS (In cm) / ABMESSUNGEN (In cm)			CATALOGUE NUMBER / PRODUKTSYMBOL	NET PRICE In EUR (without VAT) / PRIS In € ohne MwSt					
	WIDTH / BREITE	DEPTH / TIEFE	HEIGHT / HÖHE		DESKTOP: MELAMINE / TISCHPLATTE IN MELAMIN			DESKTOP: MELAMINE AND VARNISHED MDF / TISCHPLATTE IN MELAMIN UND MDF LACKIERT		
					FRONT: HPL AND MELAMINE / FRONT: HPL-MELAMIN	FRONT: VARNISHED MDF / FRONT: MDF LACKIERT	FRONT: NATURAL VENEER / FRONT: FURNIER	FRONT HPL AND MELAMINE / FRONT: HPL-MELAMIN	FRONT: VARNISHED MDF / FRONT: MDF LACKIERT	FRONT: NATURAL VENEER / FRONT: FURNIER

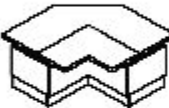
**COUNTERS
/ THEKEN**

	139/ 139	81	74	H18	1 363	1 426	1 580	1 464	1 535	1 692
	139/ 139	106	74	H19	1 386	1 450	1 605	1 502	1 572	1 730
	130/ 130	81	74	H21	1 514	1 608	1 842	1 677	1 777	2 017
	155/ 155	106	74	H22	1 584	1 680	1 918	1 863	1 970	2 218

**UPPER PARTS
/ AUFSATZ**

	45	22	45	H23	402	Upper part, front, Sand-blasted glass in horizontal lines, top solid sand-blasted glass, glass thickness 10mm / Front aus Sandglas mit Streifen, Platte einheitlich sandbeschichtet, Glasstärke 10mm				
	45	22	45	H24	412	Upper part, MDF 25mm, covered with PCV foil, colour stainless steel, front milled in horizontal lines / MDF 25 mm, mit resistenten PVC Folie in einer gebürsteten Struktur, Alufarben				

VIEW AND PROJECTION OF THE OBJECT
/ ANSICHT DES OBJEKTS

DIMENSIONS (in cm)
/ ABMESSUNGEN (in cm)

CATALOGUE
NUMBER
/ PRODUKTSYMBOL

NET PRICE in EUR (without VAT)
/ PREIS in € ohne MwSt

WIDTH / BREITE	DEPTH / TIEFE	HEIGHT / HÖHE
-------------------	------------------	------------------

UPPER RAILINGS
/ OBERE RAILING



185	5	25	H25	240
155	5	25	H26	224
130	5	25	H27	196
125	5	25	H28	196
95	5	25	H29	179
60	5	25	H30	164

UPPER RAILINGS
/ UNTERE RAILING



185	9	25	H31	359
155	9	25	H32	355
130	9	25	H33	292
125	9	25	H34	292
95	9	25	H35	245
60	9	25	H36	214

BBM Meyer
 Brückenhofweg 8
 34466 Wolfhagen
 Tel.: +49(0)5606534150
 Fax: 03222-684 9294
 Email: info@bbm-meyer.de
 Internet: www.bbm-meyer.de